

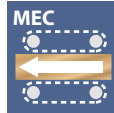

3060

PROGRAMA REVESTIMIENTOS PISO - FORRO

Este conjunto de cabezales permite la fabricación de 5 tipos de machimbrado, como se puede apreciar en los dibujos.



Piso

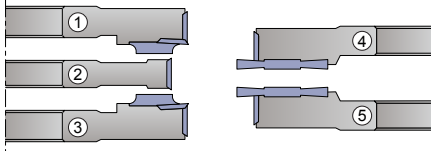

Cielo-Forro

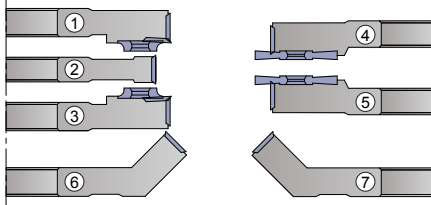

Machimbrado Doble Chaflán

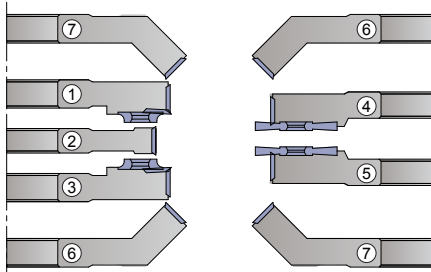

Machimbrado

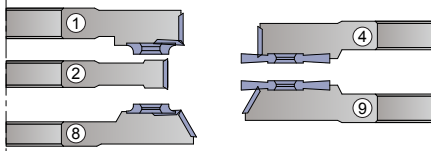

Piso Max

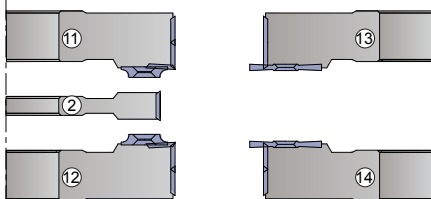

Cabezal n	D mm	d mm	Z n	l n	R n	RPM max.	Código
1	160	30/50	4	2	2	8300	30604001
2	146	30/50	2			8300	30602002
3	159	30/50	4	2	2	8300	30604003
4	173	30/50	4	2		8300	30604004
5	173	30/50	4	2		8300	30604005
6	175	30/50	2			8300	30602006
7	175	30/50	2			8300	30602007
8	172	30/50	4	2	2	8300	30604008
9	172	30/50	4		2	8300	30604009
11	160	30/50	4	2	2	8300	30604011
12	159	30/50	4	2	2	8300	30604012
13	173	30/50	4	2		8300	30604013
14	173	30/50	4	2		8300	30604014

Conjunto 1-2-3-4-5	Piso	30600020
Conjunto 1-2-3-4-5-6-7	Cielo-Forro	30600030
Conjunto 1-2-3-4-5-6-7-6-7	Machimbrado Doble Chaflán	30600040
Conjunto 1-2-4-8-9	Machimbrado	30600050
Conjunto 2-11-12-13-14	Piso Max	30600060

Repuestos

Tipo	Dimensiones	Código
1 Cuchilla	22x16x5 R3	79007500
2 Cuchilla	34x16x3	79009600
3 Cuchilla	14x14x2	79020000
4 Perno	M5x7	G-001018
5 Perno	M5x10	G-001019

①



②

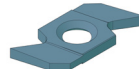

③



④



⑤



3060

PROGRAMA REVESTIMIENTOS PISO - FORRO

Piso

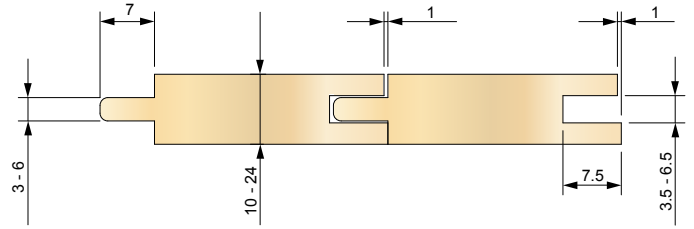
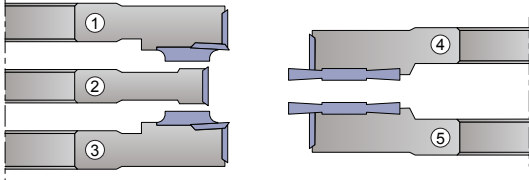

Cielo-Forro

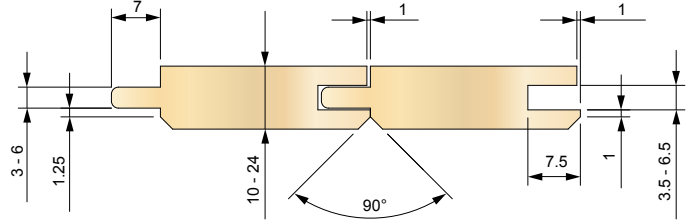
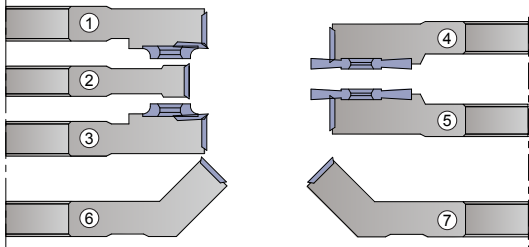

Machimbrado Doble Chafán

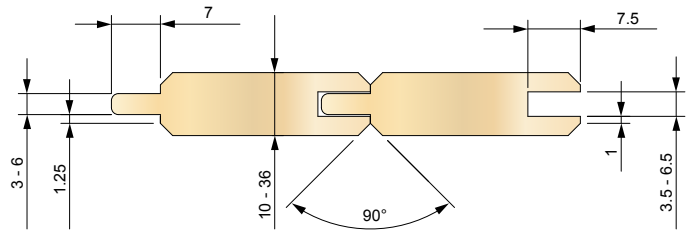
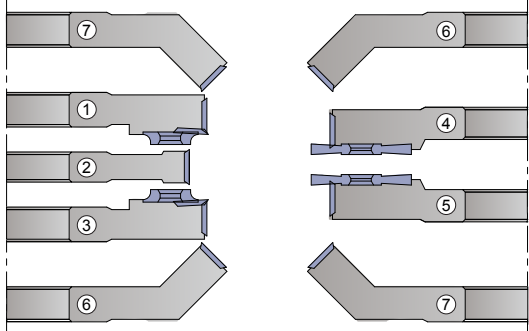

Machimbrado

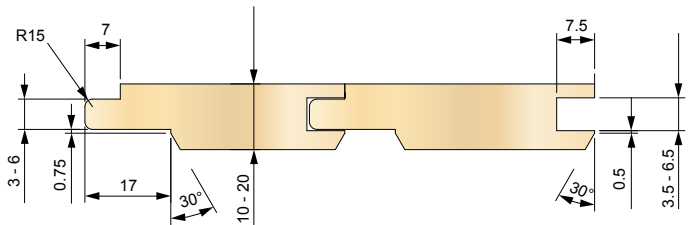
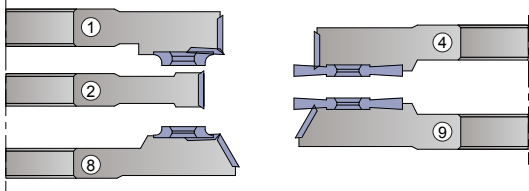

Piso Max

